

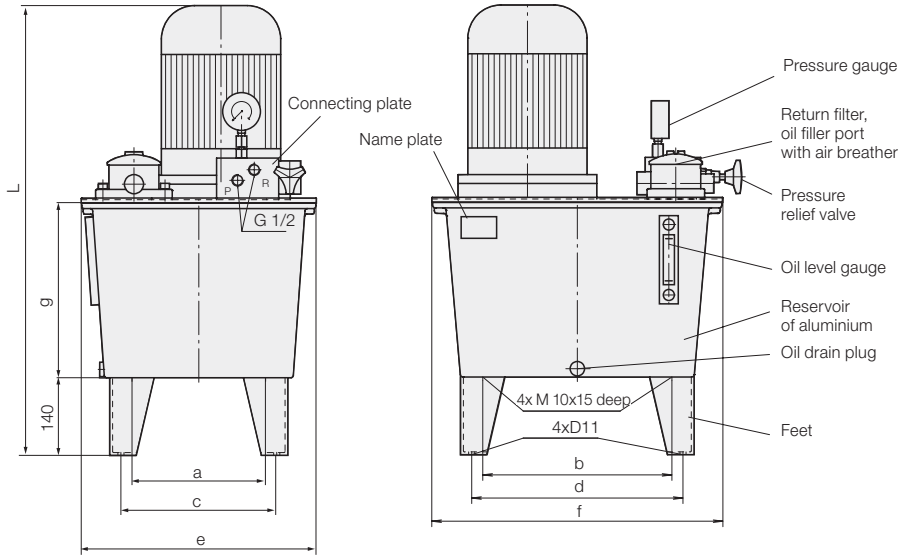

Power Units

Oil reservoir V = 27 l, 40 l, and 63 l

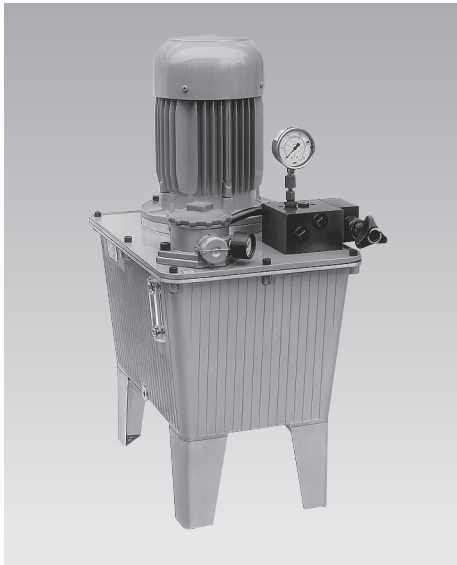

Technical data

Design	
- Gear pump	max. 200 bar
- Piston pump	max. 500 bar
- Pump combination	max. 80/500 bar
Mounting	Foot mounting
Porting	G 1/4 and G 1/2
Direction of rotation	(viewed from above onto drive shaft) clockwise
- Gear pump	any
- Piston pump	counterclockwise
- Pump combination	counterclockwise
Mounting position	upright
Usable oil volume	half of the reservoir volume
Vol. efficiency	$\eta_{vol} = 85-95\%$

Electrical data

Nominal voltage	230/400V up to 2.2 kW 400 V from 3 kW
Power system	3-phase AC, 50 Hz
Code class	IP 54
Relative duty cycle ED	Depends on operating pressure. Details for 100% and 40% ED (see page 2)

Dimensions

	V = 27 l	V = 40 l	V = 63 l
a	176	241	282,5
b	326	341	422,5
c	216	281	322,5
d	366	381	462,5
e	341	424	474
f	491	525	615
g	285	315	365
L	see page 2		

Other data see table and data sheet A 0.100.

Optional oil level and temperature control.

Part no.	for V = 27 l	3822006
	for V = 40 l	3822048
	for V = 63 l	3822005

Piston pump with pressure filter

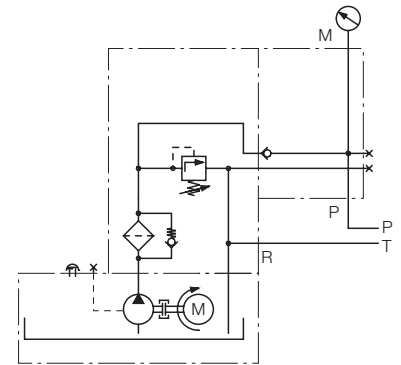

Piston pump with return filter

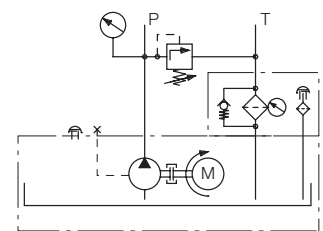

Gear pump

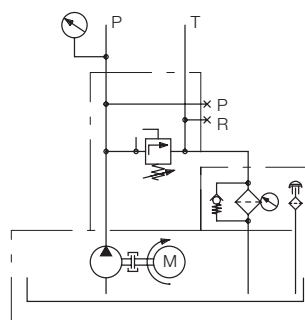

Pump combination

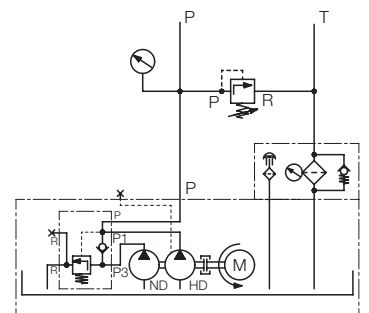

The calculation of the relative duty cycle is based on a cycle of 10 min. At 40% ED e.g. the maximum load within the cycle should not exceed 4 min. During the remaining time the motor can be loaded up to 50% of the nominal output rating and should run continuously.

Flow rate [ccm/s]	Operating pressure at [l/min]	Nominal rating [kW]		RF ²⁾ LV ²⁾	L ³⁾ V=27 l [mm]	L ³⁾ V=40 l [mm]	L ³⁾ V=63 l [mm]	Weight [kg]			Part no. Reservoir volume				
		100% ED ¹⁾	40% ED				V=27 l	V=40 l	V=63 l	V=27 l	V=40 l	V=63 l			
Power unit with gear pump – direction of rotation: clockwise															
75	4.5	60	85	0.75	RF	683	–	–	34	–	–	8142 120	–	–	
		200	200	2.2	RF	759	792	842	44	55	59	8145 120	8145 140	8145 160	
102	6.2	45	60	0.75	RF	683	–	–	34	–	–	8152 120	–	–	
		100	125	1.5	RF	725	758	–	37	48	–	8154 120	8154 140	–	
146	8.8	45	60	0.75	RF	683	716	–	35	46	–	8156 120	8156 140	–	
		90	110	1.5	RF	725	758	808	38	49	55	8157 120	8157 140	8157 160	
		175	200	3.0	RF	–	793	843	–	60	64	–	–	8159 140	8159 160
200	12	50	70	1.5	RF	725	758	808	38	49	55	8164 120	8164 140	8164 160	
		115	140	3.0	RF	–	793	843	–	60	64	–	–	8166 140	8166 160
		160	190	4.0	RF	–	809	859	–	68	72	–	–	8167 140	8167 160
		200	200	5.5	RF	–	858	908	–	77	82	–	–	8168 140	8168 160
267	16	40	50	1.5	RF	725	758	808	39	50	56	8174 120	8174 140	8174 160	
		60	75	2.2	RF	760	793	843	46	57	61	8175 120	8175 140	8175 160	
		85	105	3.0	RF	–	793	843	–	61	65	–	–	8176 140	8176 160
		115	140	4.0	RF	–	809	859	–	69	73	–	–	8177 140	8177 160
		165	195	5.5	RF	–	858	908	–	78	83	–	–	8178 140	8178 160
400	24	40	50	2.2	RF	760	793	843	46	57	61	8185 120	8185 140	8185 160	
		55	70	3.0	RF	–	793	843	–	61	65	–	–	8186 140	8186 160
		80	95	4.0	RF	–	809	859	–	69	73	–	–	8187 140	8187 160
		100	120	5.5	RF	–	858	908	–	78	83	–	–	8188 140	8188 160
		150	180	7.5	RF	–	–	946	–	–	105	–	–	–	8189 160
Power unit with piston pump – direction of rotation: any															
100	6.0	315	–	4.0	RF	–	805	855	–	71	75	–	8267 140	8267 160	
140	8.4	315	–	5.5	RF	–	861	911	–	79	83	–	8268 140	8268 160	
200	12.0	315	–	7.5	RF	–	899	949	–	104	108	–	8269 140	8269 160	
100	6.0	–	350	4.0	RF	–	805	855	–	71	75	–	8277 140	8277 160	
140	8.4	–	350	5.5	RF	–	861	911	–	79	83	–	8278 140	8278 160	
200	12.0	–	350	7.5	RF	–	899	949	–	104	108	–	8279 140	8279 160	
61	3.7	–	500	3.0	DF	756	789	839	53	64	68	8256 120	8256 140	8256 160	
88	5.3	–	350	3.0	RF	756	789	839	62	67	71	8252 120	8252 140	8252 160	
88	5.3	–	500	4.0	RF	–	805	855	–	75	79	–	8257 140	8257 160	
123	7.4	–	330	4.0	RF	–	805	855	–	77	81	–	8253 140	8253 160	
123	7.4	–	500	5.5	RF	–	861	911	–	84	88	–	8258 140	8258 160	
Power unit with combination of gear pump and piston pump – direction of rotation: counterclockwise															
150/25	9.0/1.5	90/500	–	1.5	LV/RF	731	764	–	42	53	–	8280 125	8280 145	–	
205/25	12.3/1.5	90/500	–	1.5	LV/RF	731	764	–	42	53	–	8281 125	8281 145	–	
150/43	9.0/2.6	80/500	–	2.2	LV/RF	756	789	–	52	63	–	–	8283 145	–	
205/43	12.3/2.6	80/500	–	2.2	LV/RF	756	789	–	52	63	–	–	8284 145	–	
266/43	16.0/2.6	80/500	–	2.2	LV/RF	756	789	–	53	64	–	–	8285 145	–	
150/61	9.0/3.7	80/500	–	3.0	LV/RF	756	789	839	60	70	74	–	8286 145	8286 165	
205/61	12.3/3.7	80/500	–	3.0	LV/RF	756	789	839	60	70	74	–	8287 145	8287 165	
150/88	9.0/5.3	80/500	–	4.0	LV/RF	–	805	855	–	78	84	–	–	8288 165	
205/88	12.3/5.3	80/500	–	4.0	LV/RF	–	805	855	–	78	84	–	–	8289 165	
150/123	9.0/7.4	80/500	–	5.5	LV/RF	–	861	911	–	85	89	–	–	8290 165	

1) Refers to electric motor only. Running time of pump at max. pressure depends on unit power losses. It should be noted that oil temperature must not exceed 70°C.

2) RF = for return filter
DF = for pressure filter
LV = for idle pressure valve

3) Dimension L = minimum height, depending on the motor type and the use of damper rings to reduce the noise level.

When using damper rings dimension L is changed as follows:

Motor 0.75 up to 1,5 kW: plus 40 mm
Motor 2.2 up to 4,0 kW: plus 45 mm
Motor 5.5 up to 7,5 kW: plus 50 mm

Valve switchings with valves ND 6 and ND 10, max. 315 bar, as per data sheet C 2.530 and C 2.531 with mounting plates G 1/4 and G 1/2, for vertical and horizontal mounting, manually operated or by solenoid

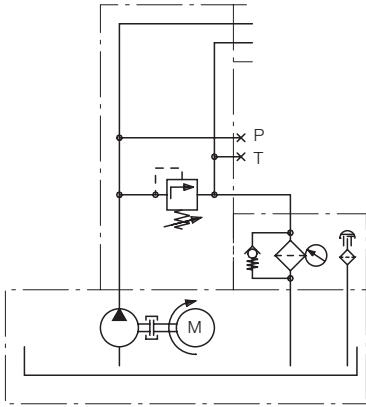

Basic power unit

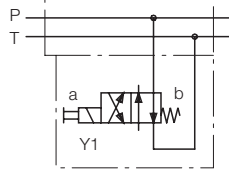

4/2 directional control valve with mounting plate for unpressurised cycles.

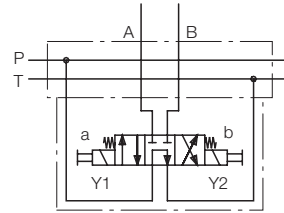

4/3 directional control valve with mounting plate for unpressurised cycles in central position. Ports A and B closed, not leakage-free.

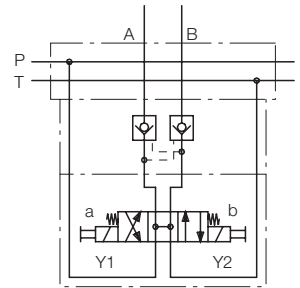

4/3 directional control valve with mounting plate for unpressurised cycles in central position. Ports A and B closed by a twin check valve, and leakage-free.

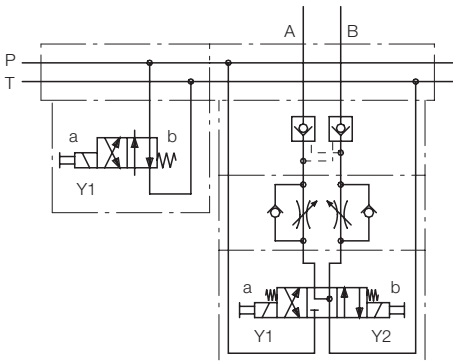

4/2 directional control valve with mounting plate for unpressurised cycles.

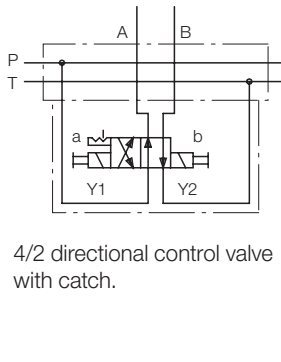

4/2 directional control valve with catch.

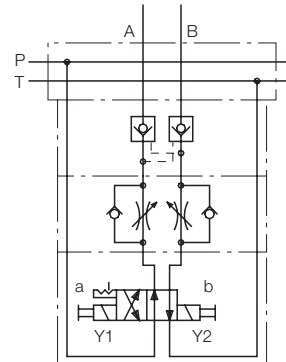

4/2 directional control valve with catch, twin flow control valve and twin check valve. Ports A and B closed and leakage-free.

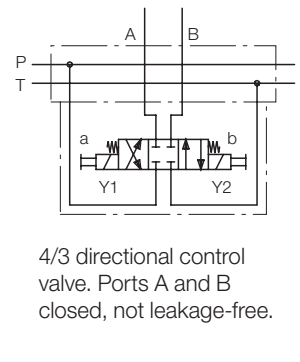

4/3 directional control valve. Ports A and B closed, not leakage-free.

4/3 directional control valve with twin flow control valve and twin check valve. Ports A and B closed and leakage-free.

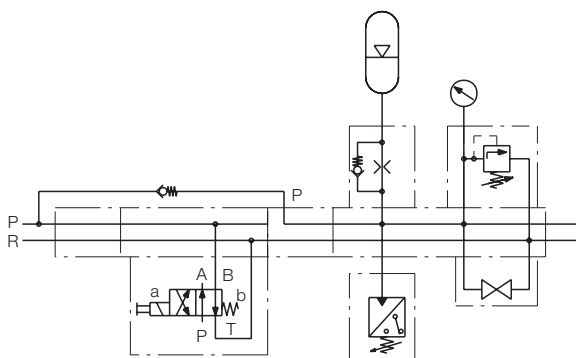

4/2 directional control valve with mounting plate for unpressurised cycles.

Accumulator connecting block with accumulator, check valve with throttling, pressure switch, drain plug, pressure reducing valve and pressure gauge.

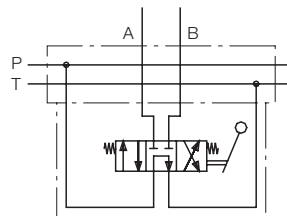

4/3 directional control valve with unpressurised cycle in central position, manually operated by lever, spring return. Ports A and B closed, not leakage-free.

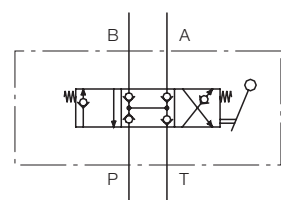

4/3 directional control valve with closed and leakage-free central position. Manual operation by lever with spring return up to an operating pressure of 300 bar. In the case of higher operating pressures there is no automatic lever return. When using this valve the power unit must function intermittently or with a valve for unpressurised cycles.

Power units with piston pumps, flow rate up to 6.0 l/min
Piston pump with pressure filter

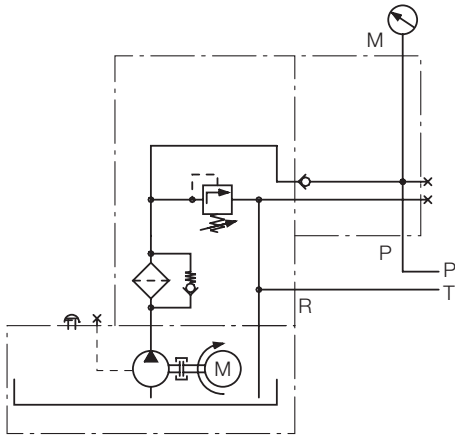

The same valves ND 4, valve blocks and control variants as used for the power units as per data sheet D 8.021 can be mounted to all power units with pressure filter, e.g. Part no. 8275 120.

Power units with piston pump, flow rate more than 6.0 l/min

For power units with piston pump e.g. 8.4 l/min, Part no. 8278 140, or with pump combination e.g. 9.0/1.5 l/min, Part no. 8280 145, with return filter valves ND 10 and mounting plates with ports G 1/2 have to be used.

When designing a power unit the surface ratios of the cylinders (e.g. in the case of Römheld cylinders 1.6:1 or in the case of swing clamps 2.75:1 up to 4:1) have to be considered, since the flow rate will increase correspondingly in the return line.

Smaller pumps have to be used accordingly. The max. admissible flow rate of valves ND 10 is 25 l/min. These valves are mounted separately on the top of the reservoir cover.

Variants of valves ND 10 in initial position on single mounting plate, Part no. 3534299

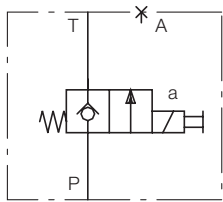

0-position: closed

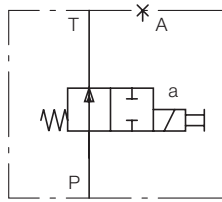

0-position: passage

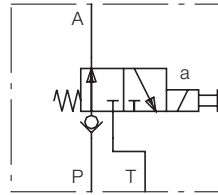

0-position: passage to the cylinder

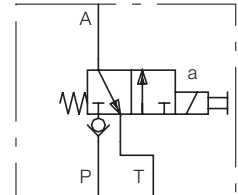

0-position: return from the cylinder

In addition, there is the possibility to install valves in block design onto series mounting plates if several functions are required.

Example: 2 x double acting with different valves, unpressurised cycle and pressure switch

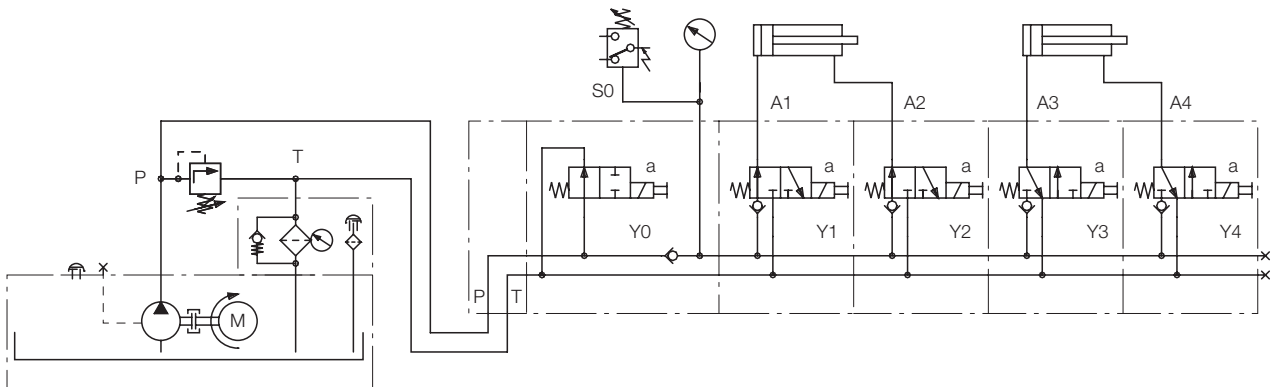

Further versions on request!

Power units with hydraulic and electric control can be designed and delivered according to your task.

– Please do not hesitate to contact us! –