

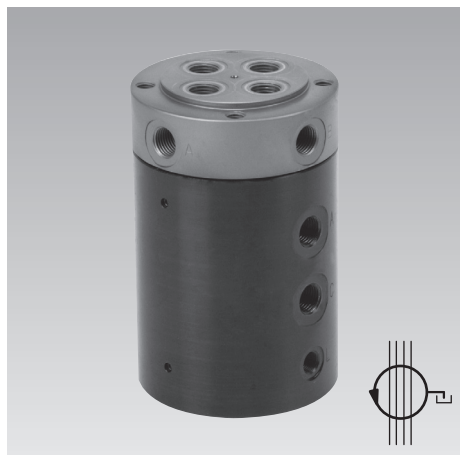

Rotary Couplings

supported by ball bearings, twin, four and six passages
ND 5, max. operating pressure 500 bar



Advantages

- Max. operating pressure 500 bar
- Min. dimensions
- Axial or radial pipe thread
- Manifold-mounting design optional
- Sturdy bearing (ball bearing)
- Low starting torque
- Protection against coolants
- Separate leakage port
- Long service life

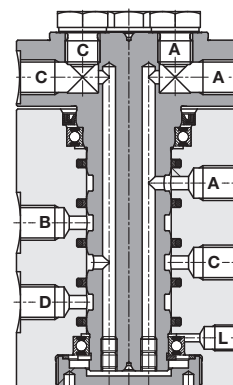

Application

Rotary couplings transfer liquid or gaseous media from a stationary to a rotating or swivelling machine part.

The most important fields of application are:

- Swivelling fixtures which cannot be connected by hoses.
- Rotating fixtures that rotate with a determined number of rotations.
- Rotary indexing tables that move in one direction of rotation more than 360 degree.
- Machine tables with swivel movements in both directions.

Description

The oil supply at the housing is made by radial pipe threads that end in circular slots of the rotary piston. From there, the hydraulic oil is led upwards through axial bore holes. The pipe connection at the rotary piston can optionally be effected radially or axially. Alternatively, a manifold-mounting type with O-ring seals is available.

The starting torque is reduced by the following measures:

- The rotary piston is supported by ball bearings.
- The running surfaces for the seals are nitrated, ground and polished.
- The special seals have low friction and are abrasion resistant.

A radial shaft seal protects the interior against dirt and coolants.

At the leakage port the little leakage can be led away in a controlled manner.

Important notes

Fixing is made precisely in axial direction at the housing or at the flange of the rotary piston. The firmly-screwed component can be connected with pipes. To compensate the torque, the other part is connected to an anti-rotation key that offers sufficient freedom of motion and avoids forced conditions as well as axial forces. That is the reason why also here high-pressure hoses have to be used instead of pipes. The leakage port at the housing must not be closed to avoid malfunctions.

Hydraulic applications

As hydraulic medium HLP as per DIN 51524-2 is prescribed. For the use of other media please contact us.

The diagrams on the following pages show the starting torque and the admissible continuous number of rotations as a function of the operating pressure.

If the rotary coupling is operated at the limit of performance (pressure + number of rotations), pay attention to sufficient supply of cooling air (see Technical data).

Use of pneumatics

A prerequisite for pneumatic use is oiled compressed air free from water. Thus, numbers of rotations up to 10 rpm are possible. A continuous operation with constant high number of rotations is not admissible, because the seals will become too hot for lack of lubrication.

Hydraulics and pneumatics

Mixed use of the individual passages is possible, e.g. air – oil – oil – air.

Examples:

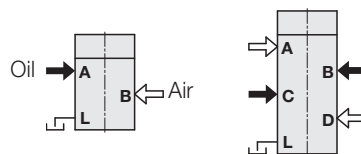

Please note the following:

1. The leakage of high-pressure seals can enter into the adjacent air passage.
2. If the hydraulic pressure is lower than the air pressure, air diffuses into the adjacent hydraulic passage and this can lead to malfunctions (air in oil).

Therefore, we recommend to separate the different media by means of an intermediate leakage passage as shown in the following example:

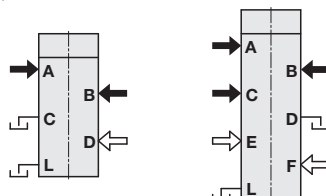

Installation and connecting possibilities

Pipe thread

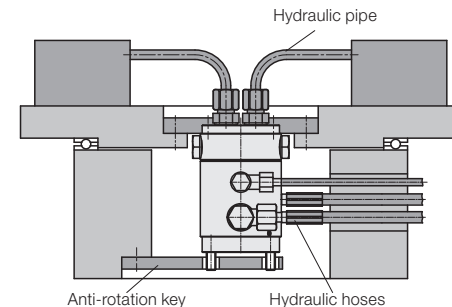
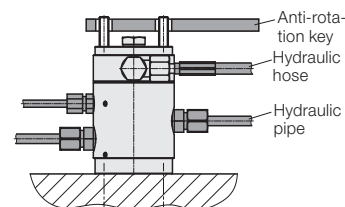

Manifold-mounting connection

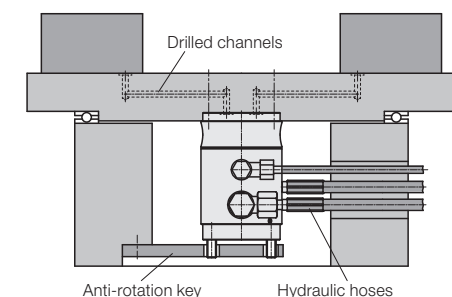

Special versions are available on request.

Twin passage rotary coupling



Pipe thread
Part no. **9282105**

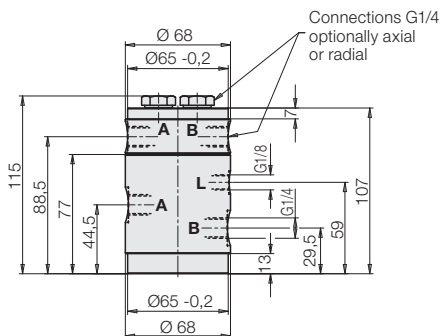

Manifold-mounting connection
Part no. **9282205**

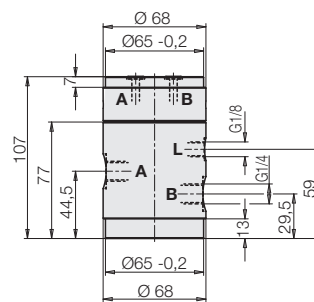

Hydraulic circuit diagram
(Example)

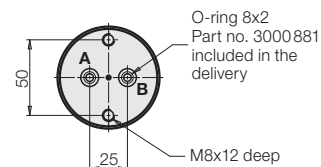
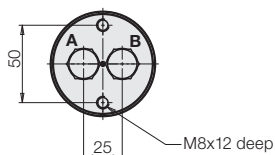
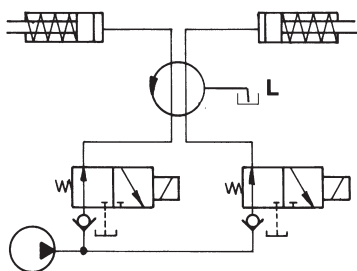

Connecting scheme

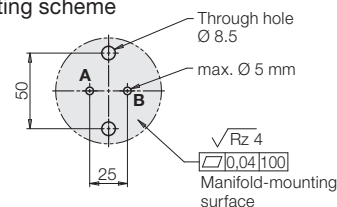

Technical data*

Number of passages	2
Port size	G 1/4
Nominal diameter	5 mm
Max. flow rate	12 l/min
Max. operating pressure	500 bar
Adm. number of rotations**	see diagram
Short-time service (ED ≤ 10%) 100 bar	500 min ⁻¹
Continuous number of rotations (ED = 100%) 100 bar***	125 min ⁻¹
Continuous number of rotations (ED = 100%) 500 bar***	100 min ⁻¹
Max. starting torque	see diagram
Operating temperature	10...60 °C
Max. leakage	25 cm ³ /100 h
Weight, approx.	2.8 kg

* With hydraulic oil HLP 22; 32; 46

** For continuous operation pay attention of sufficient supply of cooling air (max. housing temperature 60 °C). This also applies to possible special versions with FKM seals.

*** Environmental temperature 22 °C

Starting torque and admissible number of rotations as a function of the operating pressure

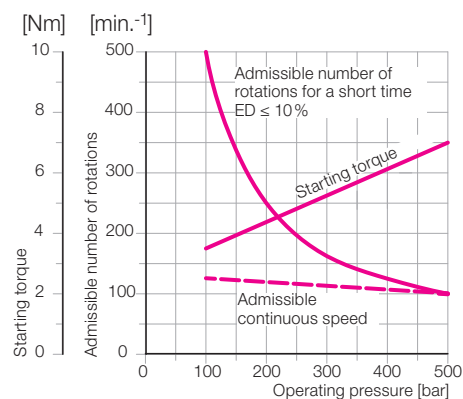

Four passage rotary coupling

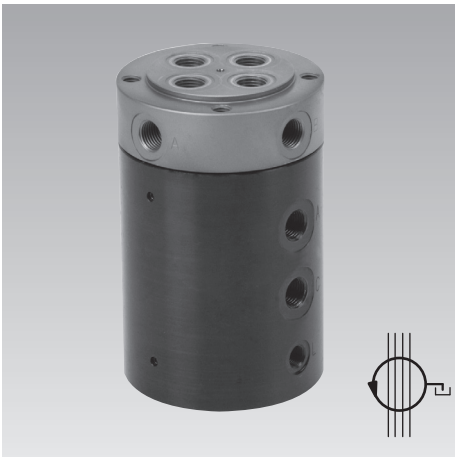

Pipe thread
Part no. **9284205**

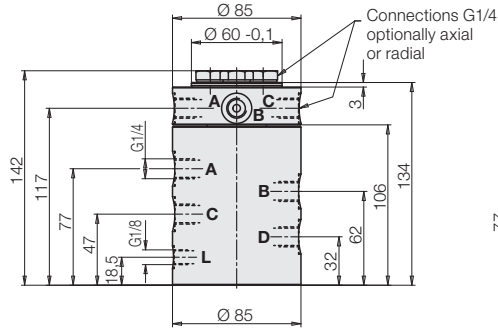

Manifold-mounting connection
Part no. **9284305**

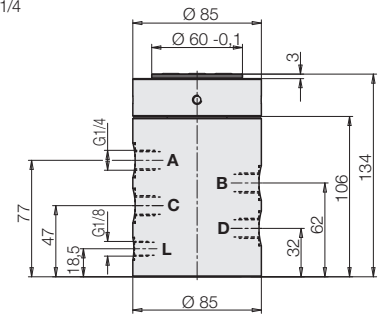

Hydraulic circuit diagram
(Example)

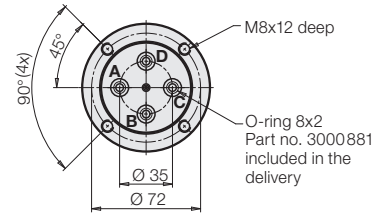
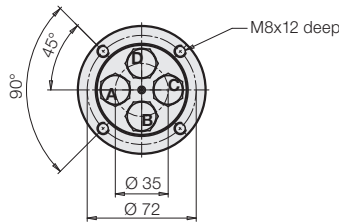
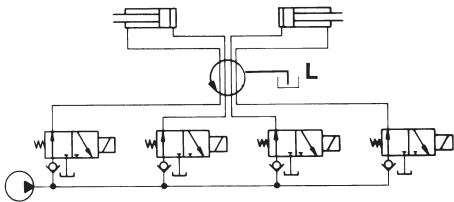

Connecting scheme

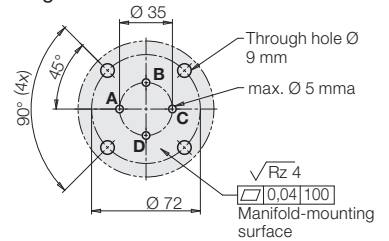

Technical data*

Number of passages	4
Port size	G 1/4
Nominal diameter	5 mm
Max. flow rate	12 l/min
Max. operating pressure	500 bar
Adm. number of rotations**	see diagram
Short-time service (ED ≤ 10%) 100 bar	200 min ⁻¹
Continuous number of rotations (ED = 100%) 100 bar***	50 min ⁻¹
Continuous number of rotations (ED = 100%) 500 bar***	40 min ⁻¹
Max. starting torque	see diagram
Operating temperature	10...60 °C
Max. leakage	30 cm ³ /100 h
Weight, approx.	5.5 kg

- * With hydraulic oil HLP 22; 32; 46
- ** For continuous operation pay attention of sufficient supply of cooling air (max. housing temperature 60 °C). This also applies to possible special versions with FKM seals.
- *** Environmental temperature 22 °C

Starting torque and admissible number of rotations as a function of the operating pressure

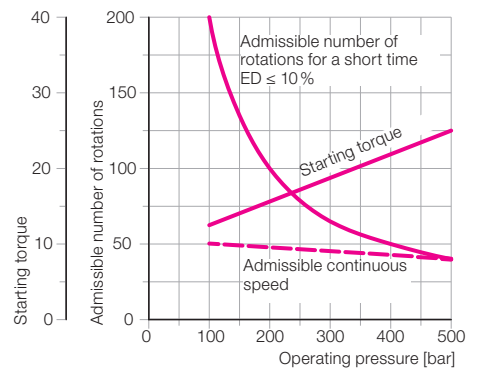

Six passage rotary coupling

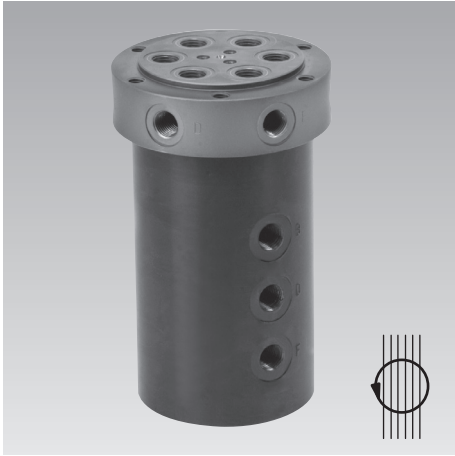

Pipe thread
Part no. **9286205**

Manifold-mounting connection
Part no. **9286305**

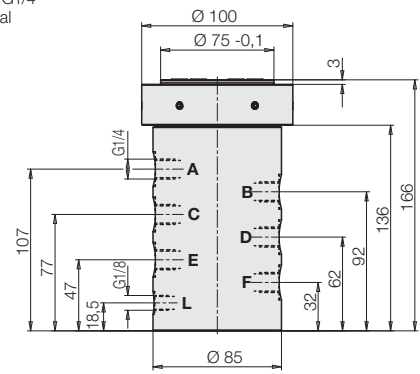
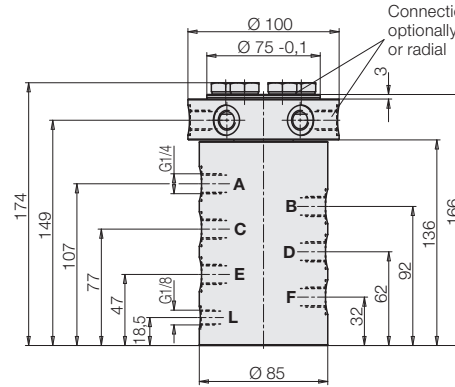

Hydraulic circuit diagram
(Example)

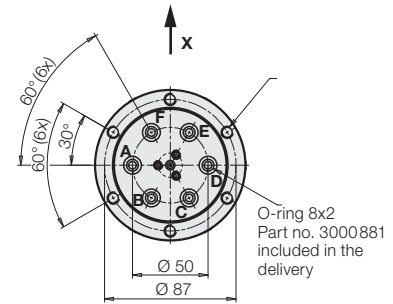
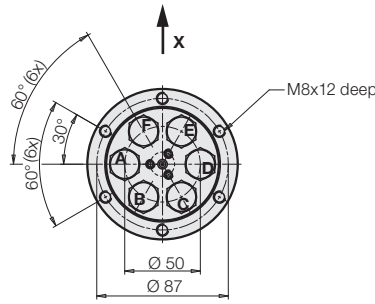
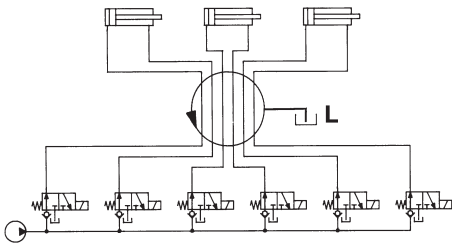

View X

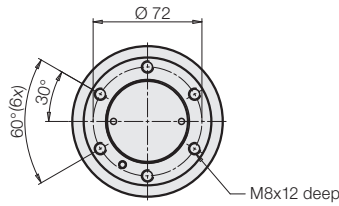

Connecting scheme

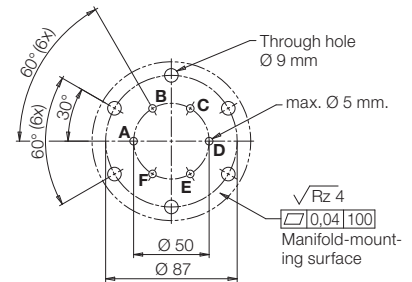

Technical data*

Number of passages	6
Port size	G 1/4
Nominal diameter	5 mm
Max. flow rate	12 l/min
Max. operating pressure	500 bar
Adm. number of rotations**	see diagram
Short-time service (ED ≤ 10%) 100 bar	125 min ⁻¹
Continuous number of rotations (ED = 100%) 100 bar***	32 min ⁻¹
Continuous number of rotations (ED = 100%) 500 bar***	25 min ⁻¹
Max. starting torque	see diagram
Operating temperature	10...60 °C
Max. leakage	30 cm ³ /100 h
Weight, approx.	7.1 kg

* With hydraulic oil HLP 22; 32; 46

** For continuous operation pay attention of sufficient supply of cooling air (max. housing temperature 60 °C). This also applies to possible special versions with FKM seals.

*** Environmental temperature 22 °C

Starting torque and admissible number of rotations as a function of the operating pressure

